

ORIGINAL RESEARCH

On-line control of nonlinear systems using a novel type-2 fuzzy logic method

Behrouz Safarinejadian*, Mohammad Karimi

Control Engineering Department, Shiraz University of Technology, Shiraz, Iran

Received: April 27, 2014
DOI: 10.5430/air.v3n2p24

Accepted: May 22, 2014
URL: <http://dx.doi.org/10.5430/air.v3n2p24>

Online Published: May 29, 2014

Abstract

In this paper, a new type-2 fuzzy logic controller (T2FLC) is proposed for on-line control of nonlinear systems. The proposed method provides more flexibility in applying human thinking in control system design in comparison with the traditional or even type-1 fuzzy logic controllers. One encounters some problems using the type-2 fuzzy logic controllers on-line because of the large volume of computations required. The main aim of this paper is to propose a new type-2 fuzzy controller with a small computational burden so that it can be used on-line. In the proposed T2FLC, the programs related to the computation of union of all qualified consequent T2MFs are divided into some sub-problems, and to design the T2FLC - not interval - we merge the Type Reducer and Defuzzifier into one step. By doing so, the computational time reduces, and the performance of our T2FLC increases so that it can be used on-line in dynamic systems. We study the noise concealing properties of the proposed T2FLC as well. The proposed method is applied to two non-linear dynamic systems, ball & beam and inverted pendulum. The results are compared with PID and type-1 fuzzy logic controllers. In the simulation results, it is also shown that the proposed controller has good noise cancelling properties.

Key Words: Online control, Type-2 fuzzy logic controller, Fuzzy logic system, Membership function

1 Introduction

Recently, the importance of Type-2 fuzzy systems has appeared to the majority of scientists, and applications of them are extensive, particularly in control problems.^[1-3] Many reported researches have shown that T2 FLCs are more capable than type-1 FLCs in handling the uncertainties.^[4] Also, it has excellent performance, similar to human operators and better than the classic controllers (e.g., PID controller) and even type-1 fuzzy systems.^[5]

In fact, the words and sentences (linguistic variable, e.g., cool, hot ...) associated with FLCs, have different meanings for each person. Also, uncertainties in inputs and outputs translate into uncertainties in antecedent's MFs and consequent's MFs regularly. Generally, everything that is related to FLC might be uncertain and fuzzy. So, the T1FLCs cannot model such uncertainties.

The original fuzzy logic sets—Type-1 Fuzzy Logic System: T1FLS—presented by Lotfi Zadeh,^[6] have been used suc-

cessfully for more than forty years; however, they could not minimize the uncertainties any more, when the researchers envisaged with some new obscurant systems that definition of their MFs needed more flexibility. The type-2 fuzzy logic controllers have been proposed because their type-2 MFs are three-dimensional and they provide more flexibility and freedom in comparison with type-1 MFs. For these reasons, they can support a wide variety of opinions. Therefore, the Type-2 fuzzy logic was proposed by Zadeh in^[7] for the first time. Many investigations were done by Mizumoto and Tanaka^[8] about type-2 fuzzy logic, but researches in this field became inconspicuous from 1977 to 1996.

In,^[9] Mendel and John reformulated all set operations—union, intersection, and complement—between T2FSs, but the usage of type-2 fuzzy sets in real computer systems was not widespread, because using type-2 fuzzy sets is very complicated and its computational load is heavy. Hence, to enhance the real-time performance of on-line ap-

*Correspondence: Behrouz Safarinejadian; Email: safarinejad@gmail.com; Address: Control Engineering Department, Shiraz University of Technology, Shiraz, Iran

plications, the interval type-2 fuzzy logic was investigated in various articles (e.g., Castro, Castillo and Martinez^[10,11]). So, Simplified interval fuzzy sets have been used in most of T2FLC's used for on-line control.^[9] But the interval FLC had less flexibility than T2FLC, and cannot minimize the uncertainty efficiently because the secondary grade of MF is not considered in the interval FLC.

Totally, paper's innovations are expressed in three parts: first, we present a new expression of the triangular type-2 membership function, which results in minimizing the effect of the uncertainties to apply the one's opinions; second, we will divide the problem into some sub-problems to calculate the union of all qualified consequent T2MFs—that will be mentioned in section VI and will be showed in Figure 4; third, to design the T2FLC—not Interval—we will merge the last two steps of controller architecture, Type Reducer and Defuzzifier, into one step with formula (10). All these innovations lead to reduction of computational load and increasing the performance of our T2FLC so that it can be used on line in dynamic systems. It is worth mentioning that the fuzzy rules and T2MFs are defined based on the knowledge of an expert about the plant.

In order to verify the proposed method, we will use the proposed T2FLC to control two nonlinear dynamic systems, inverted pendulum and ball & beam, on line. As long as the transient response of T1FLCs and T2FLCs are so similar,^[4,5,12] we tried to compare between T2FLC and PID controllers—an alternative economic controller—to check the performance of our T2FLC in sense of transient behavior. Robustness of fuzzy systems, especially T2FLSs, is excellent in noisy environments.^[12] However, almost all of T2FLSs have been used in static cases to utilize such robustness^[13,14] due to its computational burden. To study this property of the proposed T2FLC, we will compare it with T1FLC in the mentioned dynamic system (inverted pendulum). This paper is organized as follows: In section II, some essential definitions associated with Type-2 Fuzzy sets will be introduced. In section III, the new expression of the triangular type-2 membership function is discussed. In section IV, at first, the structure of the proposed T2FLC will be explained briefly, and then their operations details are described by bringing up an example. In sections V and VI, our proposed T2FLC will be applied to two nonlinear plants, ball & beam and inverted pendulum, and the results will be compared against a PID controller in sense of stability and transient response. The noise canceling behavior of T1FLC and T2FLC in inverted pendulum system is com-

pared in section VII. Eventually, section VIII concludes the paper.

2 Essential definitions

In this section, we provide definition of type-2 fuzzy sets and some important associated operations with this assumption that the type-1 fuzzy sets and their operators are familiar for the readers.

Definition 1: (J. Mendel and R. John^[7]) A type-2 fuzzy set denoted by \tilde{A} , is characterized by a type-2 MF $m_A(x, u)$ with $x \in X$ and $u \in J_x \subseteq [0, 1]$;

$$\tilde{A} = ((x, u), \mu_{\tilde{A}}(x, u)) \mid \forall x \in X, \forall u \in J_x \subseteq [0, 1] \quad (1)$$

In which, $0 \leq \mu_{\tilde{A}}(x, u) \leq 1$. A type-2 fuzzy set can be also expressed as:

$$\tilde{A} = \int_{x \in X} \int_{u \in J_x} \mu_{\tilde{A}}(x, u)/(x, u); J_x \subseteq [0, 1] \quad (2)$$

where u is a primary grade and $m_A(x, u)$ is a secondary grade. For discrete universe of discourse, \int is replaced by \sum in (1) and (2). Since (\int, \sum) denote union, the repetitious points in type-2 set have same concept and all of them are the same point. Also, if the $m_A(x, u)$ of some points are zero, they are unvalued, and they can be omitted.

Definition 2: At each value of x , say $x = x'$, the two-dimensional plane whose axes are u and $m_A(x', u)$, is called a vertical slice of T2FS \tilde{A} . A vertical slice is a type-1 fuzzy set itself.

Definition 3: The MF of a type-2 fuzzy set, \tilde{A} , is three-dimensional where the third dimension is the value of the MF at each point on its two-dimensional domain that is called its footprint of uncertainty (FOU).

Definition 4: Using theorem 3 of Mendel and John^[7] the union between two T2FSs \tilde{A} and \tilde{B} is given as (5):

$$\tilde{A} = \sum_{x \in X} [\int_{u \in J_x^u} f_x(u)/u]/x \quad (3)$$

$$\tilde{B} = \sum_{x \in X} [\int_{w \in J_x^w} g_x(w)/w]/x \quad (4)$$

$$\tilde{A} \cup \tilde{B} = \int_{j=1}^{n_A} \int_{i=1}^{n_B} [F_{x_1}(u_1^j, w_1^i)/(u_1^j \circ w_1^i)]/x_1 + \dots + [F_{x_N}(u_N^j, w_N^i)/(u_N^j \circ w_N^i)]/x_N \quad (5)$$

where

$$F_{x_i}(w_1^j, w_1^i) = f_{x_i}(w_1^j) * g_{x_i}(w_1^i) \tag{6}$$

In (5), (6), * is a t-norm (e.g., minimum, product...) and d

is a t-conorm (e.g., maximum).

Definition 5: Using theorem 3 of Mendel and John,^[7] the intersection between two type-2 fuzzy sets \tilde{A} and \tilde{B} is given as:

$$\tilde{A} \cap \tilde{B} = \int_{j=1}^{n_A} \int_{i=1}^{n_B} [F_{x_1}(w_1^j, w_1^i) / (w_1^j * w_1^i)] / x_1 + \dots + [F_{x_N}(w_N^j, w_N^i) / (w_N^j * w_N^i)] / x_N \tag{7}$$

where $F_{x_i}(w_1^j, w_1^i)$ is given in (6).

3 Fabrication a T2MF

In associated with expression of T1MF, there are some impediments. The T1MF cannot completely handle the linguistic and numerical uncertainties with fuzzy membership functions. For example, person #1 bounds the domain of hot temperature's T1MF like Figure 1, the green triangular T1MF, and person #2 bounds it, like the red triangular T1MF in Figure 1;

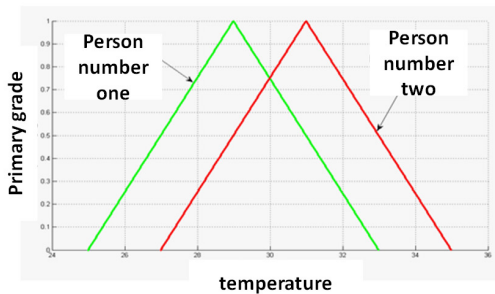

Figure 1: The triangular T1MFs of hot in variety opinions

Accordingly, we have many different opinions, also many T1MFs about hot temperature. Usually the middle (the blue T1MF) of FOU (Fig. 2) is the most possible one; therefore, it must have bigger secondary grade than other T1MFs.

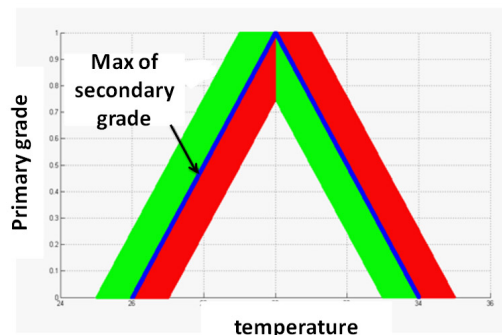

Figure 2: FOU of a T2MF

Thereupon, we propose a T2MF like Fig. 3 that, as the T1MF's domain are increased (move to right side), the μ of them are increased too, shown by green color, until arrived middle of FOU, after that, this algorithm is resumed inversely shown by red color.

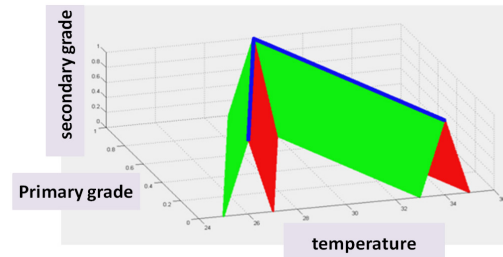

Figure 3: A T2MF of temperature

In this paper, we use this T2MF to minimize the uncertainties, by attributing the uncertainties to the third-dimension.

4 Type-2 fuzzy logic controller

A T2FLC is constructed by a structure similar to that of T1FLC. It consists of Fuzzifier, Inference Engine, Rule Base, Type Reducer and Defuzzifier. In this section, we define the components of T2FLC briefly first. Afterwards, we explain them in more detail, using an example.

A. Generally explanation

Figure 4 depicts the components of the T2FLC, which will be explained as follows:

Fuzzifier: It fuzzifies the crisp inputs into general type-2 fuzzy sets. In this paper, we use singleton fuzzification, therefore, we have only a single point of nonzero membership instead of a type-2 fuzzy set.

Rule Base: In this part, we are involved by some IF-THEN linguistic rules, linguistic variables and other related terminology. As you know, quantification of this rules are so important to FLC's sketcher. Heretofore, many papers proposed the variety designing method.^[16,17]

Inference Engine: It combines the fired rules and gives a mapping from inputs type-2 fuzzy sets to outputs type-2 fuzzy sets. In this paper, we use the Mamdani's inference model.

Type Reducer: The type-2 fuzzy outputs of the inference engine are processed by the Type Reducer and it leads to the type-1 fuzzy set called the type reduced set.

Defuzzifier: After reducing set's type, it will be defuzzified to obtain crisp outputs, just like a type-1 defuzzifier. There exist many methods of defuzzification (e.g., centroid, center average, maximum). Since the centroid defuzzification method is more efficient, it will be used in this paper.

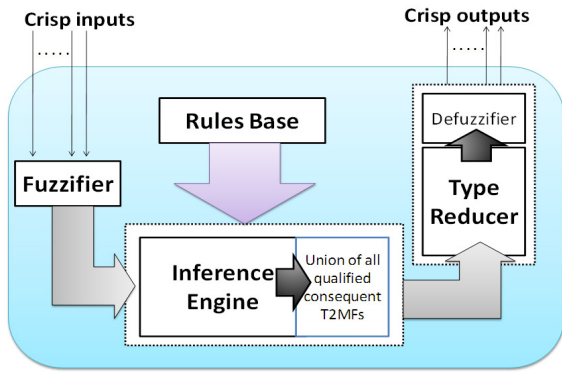

Figure 4: Block diagram of a T2FCL

B. An example of T2FCL

In order to show how our proposed T2FCL works, we provide an example below.

Assume \tilde{A} , \tilde{B} , \tilde{C} , \tilde{D} and \tilde{E} are T2MF's, and two fuzzy Rules are given as:

$$IF x_1 \in \tilde{A}, x_2 \in \tilde{B}, THEN y \in \tilde{C} \tag{8}$$

$$IF x_1 \in \tilde{D}, x_2 \in \tilde{B}, THEN y \in \tilde{E} \tag{9}$$

where, x_1 and x_2 are two inputs of T2FCL and y is its output. The typical values of inputs are $x_1=3.5, x_2=3$. In this paper, all the t-norms are assumed to be "minimum" and all the t-conorms are "maximum". The singleton fuzzification method has been used as mentioned previously. Therefore, inputs of the Inference Engine will be crisp points. According to,^[15] we divide the procedure followed by the inference engine into four steps:

- 1) The crisp known inputs ($x_1=3.5, x_2=3$) give a vertical slice (a T1MF) in each antecedent's set ($\tilde{A}, \tilde{B}, \tilde{D}$), which are called Set Of Compatibility (figure 5). Therefore, two vertical slices are given for both of the rules (8) and (9).
- 2) The vertical slices are combined with respect to antecedent T2MFs, and using the Mamdani's fuzzy implication. In consequence, one T1MF is obtained for each rule that is called: "Set of Firing Strength" or "Set of Fulfillment".
- 3) The firing strength's sets are applied to the consequence T2MFs part of the rules: (\tilde{C}, \tilde{E}). Hence, it generates a Qualified Consequent T2MF for each rule.
- 4) Union of all the qualified consequent T2MFs are calculated to obtain an Overall Output T2MF (figure 7). Since

this step has complicated computations, we divide the problem into several sub-problems in order to enhance the excellent performance. For example, if we have four sets for getting union, we use union function just three times: we get union of two pairs of them first, and then the union of two sets that resulted in the previous step will be calculated. Using such techniques in writing the programs we can decrease the run time of controller.

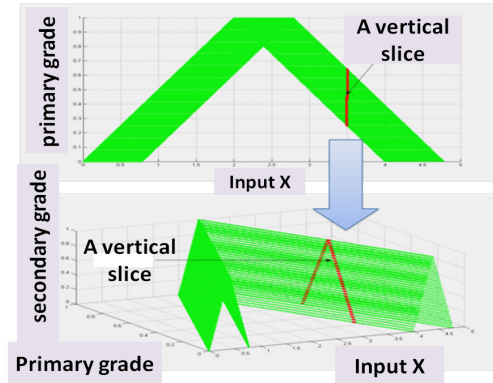

Figure 5: The Set Of Compatibility for $x=3.5$

To merge the type reduction and defuzzification steps into one step, we are seeking to obtain the projection of the center of mass related to a three-dimensional membership function—overall output T2FMF—onto the output axis Y. Assume that we define a discrete overall output T2FMF as $\{(x_i, u_i, \mu(x_i, u_i)) | i = 1, \dots, m\}$ in which m represents the numbers of discrete points related to the T2FMF. Notice that the primary grade related to the projection of a three-dimensional point such as $(x_i, u_i, \mu(x_i, u_i))$ onto the surface of the primary grade-output Y can be achieved by multiplying u_i by $\mu(x_i, u_i)$, that is, the type reduced T2MF—which is a FOU of the T2MF—is defined as $\{(x_i, u_i \times \mu(x_i, u_i)) | i = 1, \dots, m\}$. Accordingly, to achieve a projection of center of mass related to the very set of the FOU onto the output axis Y, the equation (10) is used.

$$y = \frac{\sum_{i=1}^N [x_i \times u_i \times \mu(x_i, u_i)]}{\sum_{i=1}^N [u_i \times \mu(x_i, u_i)]} \tag{10}$$

It is worth mentioning that with some alteration in the very equation it can be used for all cases.

All these steps for Rule (8) are shown in Figure 6 and Figure 7.

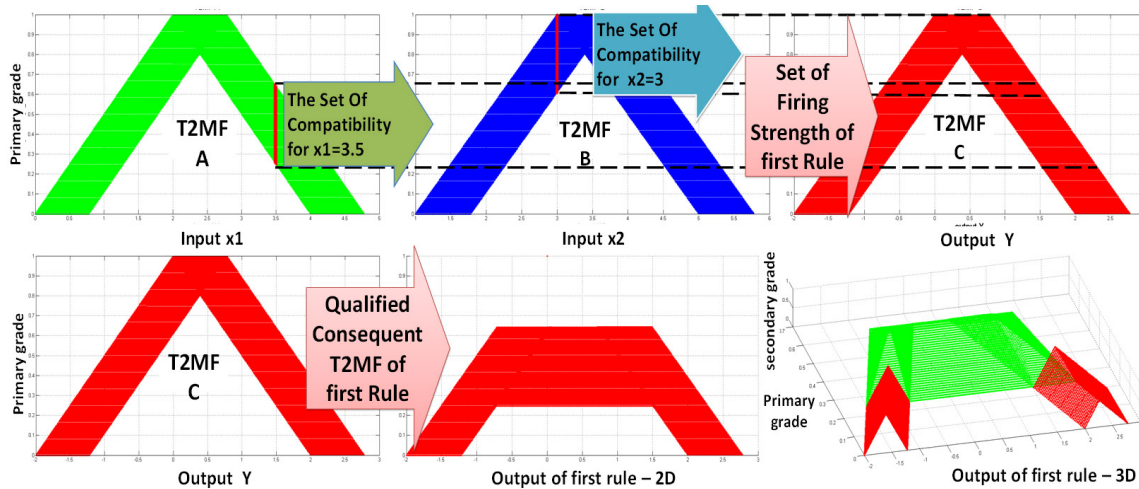

Figure 6: Calculating of the Rule (8)

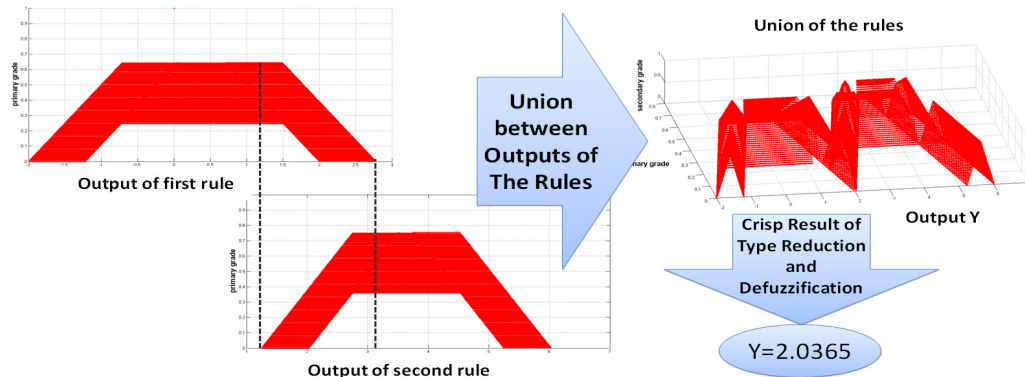

Figure 7: The Overall Outputs T2MF, Defuzzification and Type reduction

5 Ball & Beam system

A. Modeling

A simplified model of a ball & beam (shown in figure 8) is given in this part. Assuming that the ball is sliding without friction along the beam, the simplified ball and beam model is: $mg \sin(\theta) = m\ddot{x}$. where, m is the mass of the ball, g is the gravitational constant, θ is the beam angle and x is the position of the ball on the beam. We consider θ as the system's input (u) and x as the system's output (y). Assume that the states of the system are x and \dot{x} , so the system model is given by: $\dot{x} = x_2, \dot{x}_2 = b \sin(u), y = x_1$ where b is a single constant created by combining actuator, sensor and the gravity constants.

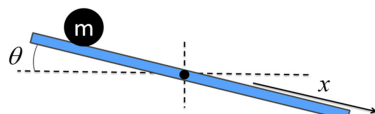

Figure 8: Ball and beam model

B. Design of the T2FLC

We consider position (x) and velocity (\dot{x}) of ball as the inputs and the control input (u) as the output of T2FLC. Figure 9 shows input and output variables' membership functions. It is worth mentioning that the specification of fuzzy rules and T2MFs are based on the knowledge of the system plant—shown in Table 1.

Table 1: Fuzzy Rules For Type-2 FLC

Position of ball (x)	Velocity of ball		
	N	Z	P
N	PL	P	Z
Z	P	Z	N
P	Z	N	NL

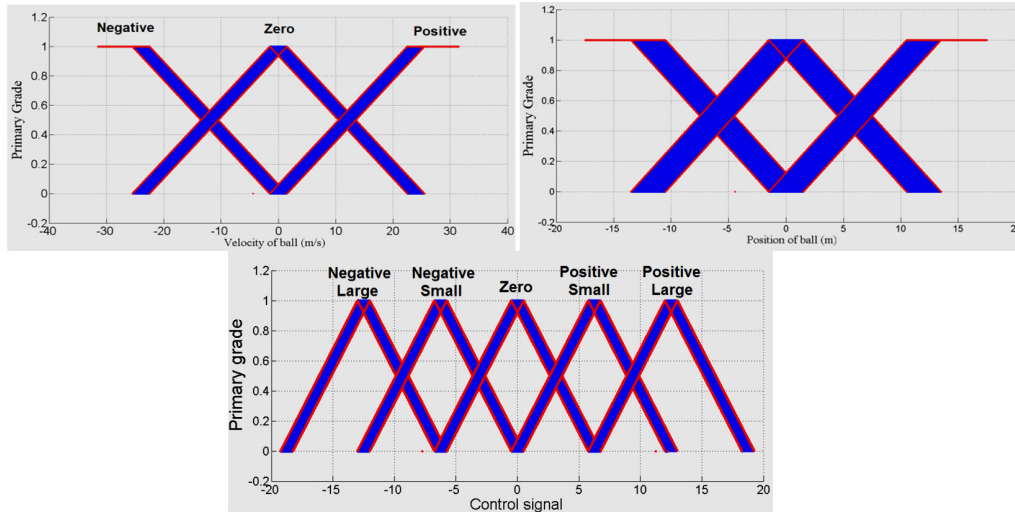

Figure 9: Type-2 Membership Functions

C. Results and discussion

The aim of this experiment is to balance the ball in the origin ($x = 0, \dot{x} = 0$) by applying the relevant control. The initial values are $x=0.4m$ and $\dot{x}=0.5m/s$. In Figure 10, the T2FLC's response is shown in comparison with a PID controller. The system with T2FLC has less settling time and maximum overshoot in comparison with the system with PID controller. Moreover, in Figure 10, there is a compar-

ison between control inputs. An advantage of the T2FLC is that its control input is more limited in comparison with the PID's control input. Notice that if control inputs are so large, it may cause damage in actuator or even in system. Using T2FLC, The computational time for a 4 second simulation is 1.43 second, so there is no problem in real-time usage of T2FLC. Accordingly, all the results show that the T2FLC has a better performance than the PID controller.

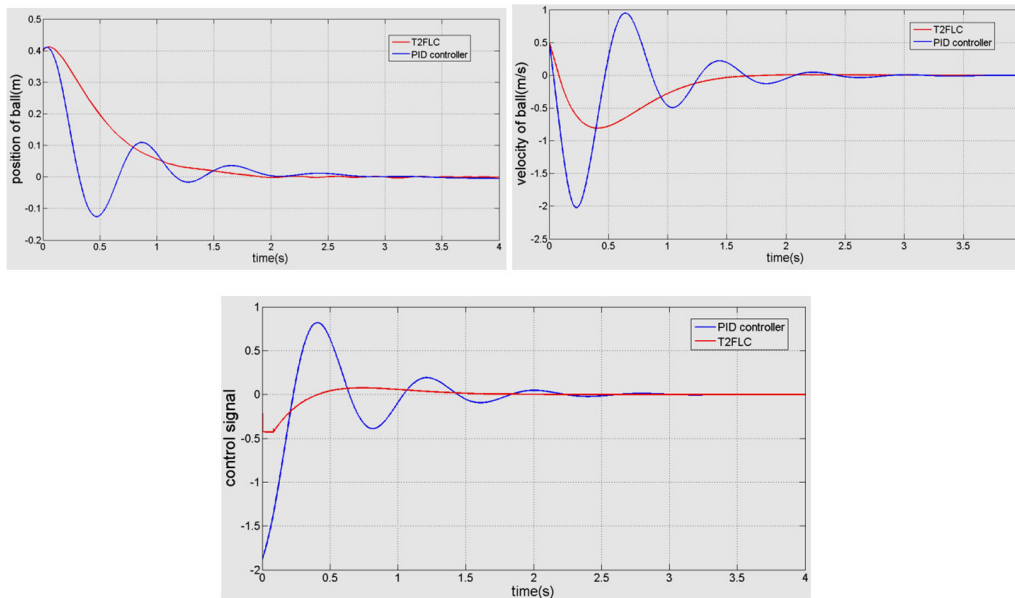

Figure 10: Position & velocity of ball and control input

6 Inverted pendulum control

A. Modeling

In this section we provide modeling of the inverted pendulum, as shown in Figure 11. This system is a prevalent classic control problem that has been used to evaluate prototype controllers (in this case, T2FLC) due to its high nonlinear-

ities and instability. The dynamical nonlinear formulas of this system are expressed as follows:

$$x_1 = \theta, \dot{x}_1 = x_2 = \dot{\theta}, \dot{x}_2 = \ddot{\theta} = f(x_1, x_2) - g(x_1, x_2) \times u \tag{11}$$

$$f(x_1, x_2) = \frac{9.8(M + m) \sin(x_1) - mLx_2^2 \sin(x_1) \cos(x_1)}{\frac{4}{3}L(M + m) - mL \cos^2(x_1)} \tag{12}$$

$$g(x_1, x_2) = \frac{\cos(x_1)}{\frac{4}{3}L(M + m) - mL \cos^2(x_1)} \tag{13}$$

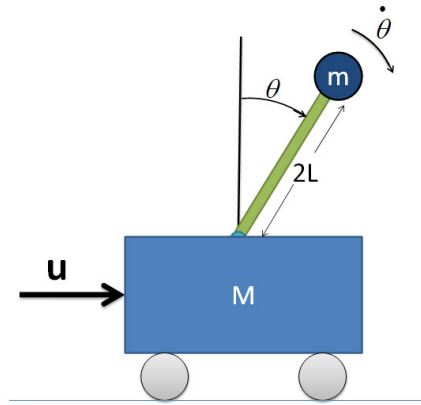

Figure 11: Inverted pendulum model

From equations (11), (12), and (13):

$$\ddot{\theta} = \frac{9.8(M+m) \sin(\theta) - mL\dot{\theta}^2 \sin(\theta) \cos(\theta) - \cos(\theta)}{\frac{4}{3}L(M+m) - mL \cos^2(\theta)}$$

Moreover, a linear actuator is contrived to correlate the force applied to cart and control input together that can be expressed as:

$$\dot{u} = -100u + 100\bar{u} \tag{14}$$

And its transfer function will be:

$$C(s) = \frac{U(s)}{\bar{U}(s)} = \frac{100}{s+100}$$

Parameters of plant:

θ : Angle of pendulum, $\dot{\theta}$: Angular velocity of pendulum

u : Force applied to the cart, \bar{u} : Input of linear actuator (control input)

m : Mass of pendulum, M : Mass of cart

$2L$: The pole length, g : Gravitational constant

The typical values are given as:

$2L=1m, m=0.5Kg, M=1Kg, g=9.8m/ s^2$

So, the plant's dynamic model can be given as:

$$\ddot{\theta} = \frac{9.8 \sin(\theta) - \cos(\theta) \left[\frac{u - 0.25\dot{\theta}^2 \sin(\theta)}{1.5} \right]}{0.5 \left[\frac{4}{3} - \frac{1}{3} \cos^2(\theta) \right]} \tag{15}$$

B. Design of the T2FLC

In this section, we design and simulate a T2FLC to control the non-linear plant of the inverted pendulum on-line and the results are compared with a traditional PID controller. The controller is used to balance the pendulum in the vertical position ($\theta=0$). We will compare and analyze their results together and realize the advantage of T2FLC in the next part.

As described in the previous sections, all of the component of the T2FLC (e.g., Fuzzifier, Inference Engine, Rule Base, Type Reducer and Defuzzifier) have been implemented using the MATLAB software. We consider the angle (θ) and angular velocity ($\dot{\theta}$) as the inputs of T2FLC and The T2FLC's output is the control input (\bar{u}). Figure 12 shows T2MF's of input and output variables.

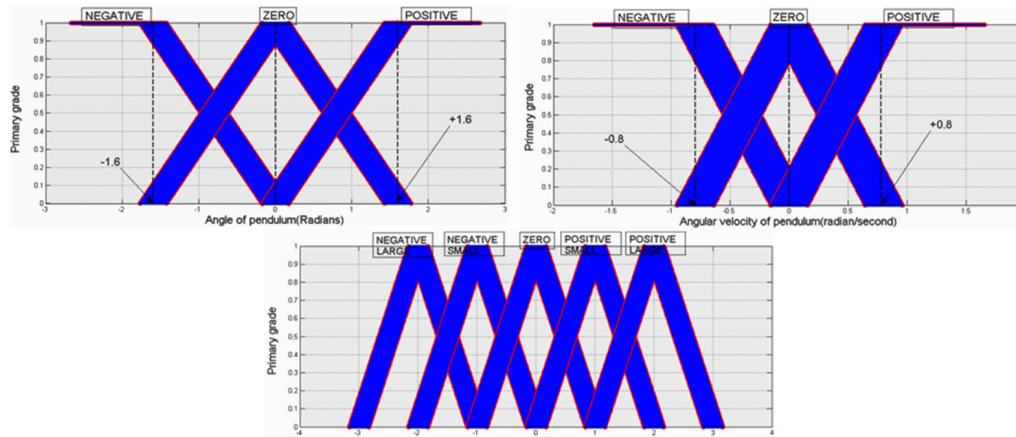

Figure 12: Type-2 Membership Functions

We specify the fuzzy rules, based on the knowledge of the system plant. For example: IF the pendulum is far from the left of vertical line (θ is negative) and its motion is counterclockwise ($\dot{\theta}$ is negative), THEN, a large force must implemented by right side (u is negative large) to neutralize the pendulum's angle (θ) and angular velocity ($\dot{\theta}$). Table 2 represents all the fuzzy rules, based on this deduction.

Table 2: Fuzzy Rules For Type-2 FLC

Angle of Pendulum (θ)	Angular Velocity of Pendulum ($\dot{\theta}$)		
	N	Z	P
N	NL	N	Z
Z	N	Z	P
P	Z	P	PL

C. Results and discussion

In this section, we will test the T2FLC and compare it with a PID controller. It will be shown that the T2FLC's performance is superior to that of the PID controller. In these experiments, we chose the initial position ($\theta(0), \dot{\theta}(0)$). The controllers try to move the pendulum toward the vertical position ($\theta = 0, \dot{\theta} = 0$). Results of the first experiment are given in Figure 13 and Figure 14. In these figures, the T2FLC's response is shown in comparison with a PID controller. The initial conditions are assumed to be $\theta(0) = 0.3, \dot{\theta}(0) = -0.7$. As it is shown in Figure 13, the maximum overshoot and the settling time t_s of T2FLC's response (Angle of pendulum) are less than that of the PID's. The angular velocities have also been compared in Figure 13. Using T2FLC, the computational time for a 3 second simulation is 0.74 seconds, so this controller is pertinent to be used in real time.

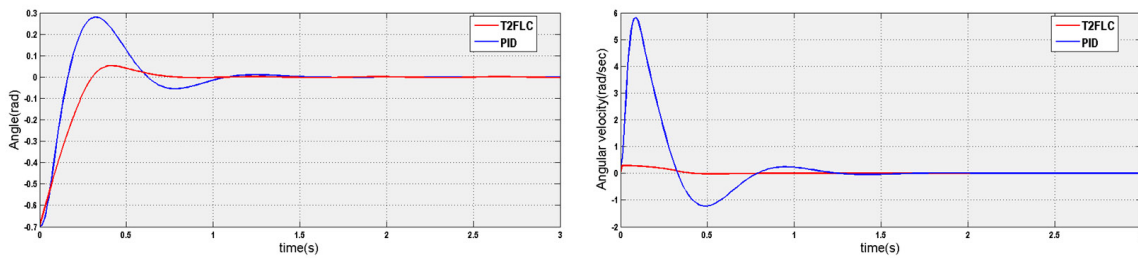

Figure 13: Angle&Angular velocity of pendulum in first experiment

In Figure 14, the results of different tests can be seen using various initial conditions as listed in table 3.

Table 3: INITIAL CONDITION OF EXPERIMENTS

Figure 14.A	Figure 14.B	Figure 14.C
$\theta(0) = -0.3$	$\theta(0) = -0.5$	$\theta(0) = -0.5$
$\dot{\theta}(0) = -0.3$	$\dot{\theta}(0) = -0.2$	$\dot{\theta}(0) = 0.3$

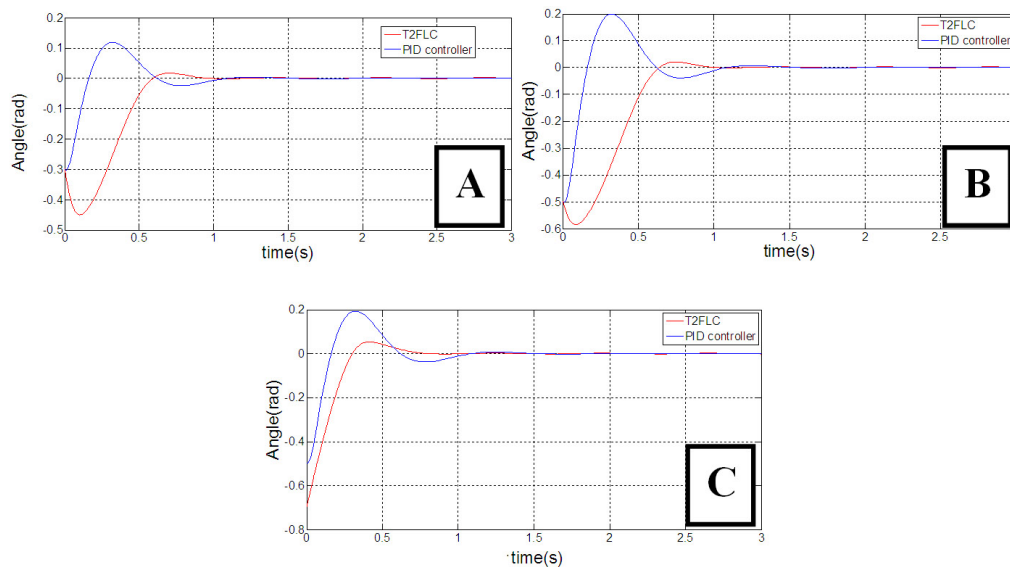

Figure 14: A,B,C : Angle of pendulum

If their overall results are compared, it is clarified that the T2FLC has a better performance than the PID controller. Also Figure 15 shows that the control input applied to actuator using T2FLC is smaller than the control input produced by the PID controller, so the T2FLC is more appropriate than PID controller.

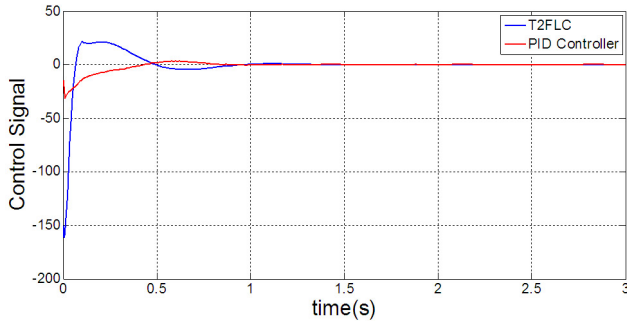

Figure 15: Control input that applied to actuator

In almost all of the practical systems, there are some noises which are undesirable. One of these noises is measurement noise that occurs in sensors. In this part, the inverted pendulum system is considered and we assume that there is mea-

surement noise in the sensors measuring angle of pendulum. We will study robustness of T2FLC versus T1FLC in presence of measurement noise. The initial value of the system and the properties of the noise are listed below: $\theta(0) = 0.7rad, \dot{\theta}(0) = -3, mean(noise) = 0rad, var(noise) = 1.485 \times 10^{-5}rad$.

Figure 16 shows angle of pendulum with and without measurement noise using T1FLC. The error between these two cases is also shown in this figure. The properties of error are expressed as below:

$$mean(error) = -0.0193rad, var(error) = 8.7627 \times 10^{-4}rad$$

The results obtained by using T2FLC with and without measurement noise are shown in Figure 17. Error mean equals to -0.0067 and its variance is $1.7507 \times 10^{-4}rad$.

$$mean(error) = -0.0067rad, var(error) = 1.7507 \times 10^{-4}rad$$

Note that most of uncertainties can be approximated with a white noise or colored noise. As it can be seen in Figures 16 and 17, using T2FLC results in an error variance less than the error variance of using T1FLC. So, it is obvious that the T2FLC is more robust than the T1FLC against the uncertainties and noises.

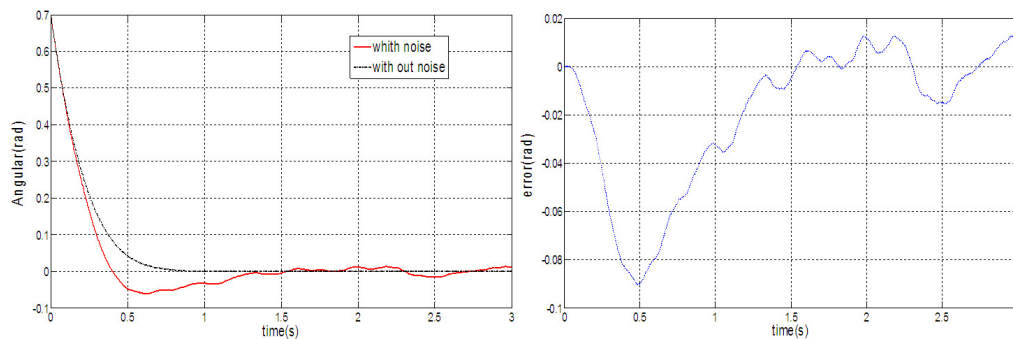

Figure 16: Error and angle of the pendulum using T1FLC

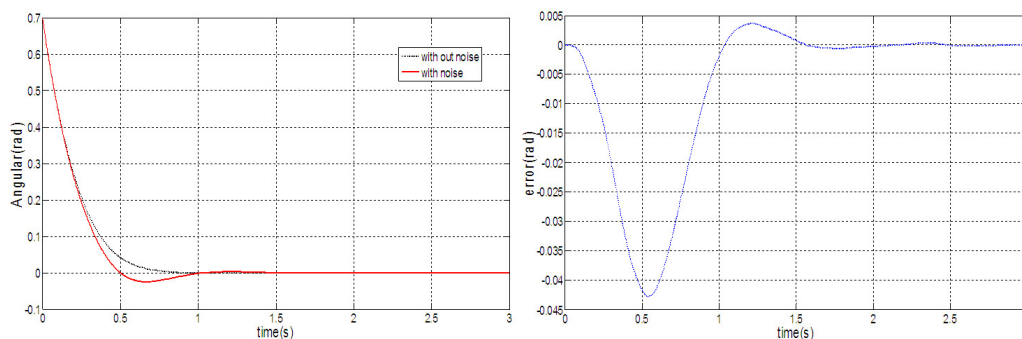

Figure 17: Error and angle of the pendulum using T2FLC

7 Conclusions

In this paper, we enhanced performance of the T2FLC to control two common non-linear systems (ball & beam and inverted pendulum) on-line. Despite of the recent works associated with type-2 fuzzy systems in which simplified in-

terval fuzzy sets have been used; exact type-2 fuzzy sets have been used in this research. Transient response of the proposed T2FLC was compared with a PID controller and its superior performance was shown. Impressibility of the T2FLC in damping the noise against the T1FLC was studied

as well. The overall simulation results demonstrate the excellent performance of the T2FLC in transient response and noise cancellation.

References

- [1] H. Hagnas; "A Hierarchical type-2 Fuzzy Logic Control Architecture for Autonomous Mobile Robots"; IEEE Transactions On Fuzzy Systems. 2004; 12(4): 524-539. <http://dx.doi.org/10.1109/TFUZZ.2004.832538>
- [2] C. C. Lee, "fuzzy logic in control systems: fuzzy logic controller-part I," IEEE Trans. on Systems, Man and Cybernetics. 1990; 20(2): 404-418. <http://dx.doi.org/10.1109/21.52551>
- [3] C. F. Juang, and Y. W. Tsao, "A self-evolving interval type-2 fuzzy neural network with online structure and parameter learning," IEEE Transactions On Fuzzy Systems. 2008; 16(6): 1411-1424. <http://dx.doi.org/10.1109/TFUZZ.2008.925907>
- [4] Dongrui Wu," On the Fundamental Differences Between Interval Type-2 and Type-1 Fuzzy Logic Controllers," IEEE Trans. Fuzzy Syst. 2012; 20(5): 832-848. <http://dx.doi.org/10.1109/TFUZZ.2012.2186818>
- [5] M.Kalyoncu,U.Onen,M.Kalyoncu,F.M.Botsali,"Pid and interval type2 fuzzy logic control of doubleinverted pendulum system",Computer and Automation Engineering (ICCAE). 2010: 117 – 121.
- [6] L.A. Zadeh, "Fuzzy Sets," Information and Control. 1965; 8: 338–353. [http://dx.doi.org/10.1016/S0019-9958\(65\)90241-X](http://dx.doi.org/10.1016/S0019-9958(65)90241-X)
- [7] LA. Zadeh, "The Concept of a Linguistic Variable and its Application to Approximate Reasoning-1," Inform.Sci. 1975; 8: 199-249. [http://dx.doi.org/10.1016/0020-0255\(75\)90036-5](http://dx.doi.org/10.1016/0020-0255(75)90036-5)
- [8] M. Mizumoto and K. Tanaka, "Some Properties of Fuzzy Sets of Type-2," Information and Control. 1976; 31: 312-340. [http://dx.doi.org/10.1016/S0019-9958\(76\)80011-3](http://dx.doi.org/10.1016/S0019-9958(76)80011-3)
- [9] J. M. Mendel and R. I. John, "Type-2 Fuzzy Sets Made Simple," IEEE Transaction on Fuzzy Systems. 2002; 10(2): 117–127. <http://dx.doi.org/10.1109/91.995115>
- [10] J. R. Castro, O. Castillo, P. Melin, "An Interval Type-2 Fuzzy Logic Toolbox for Control Applications,"IEEE International conference on Fuzzy Systems. July 2007: 1-6.
- [11] Q. Liang and, J. Mendel, "Interval type-2 fuzzy logic systems: Theory and design," IEEE Transactions Fuzzy Systems. 2000; 8: 535–550. <http://dx.doi.org/10.1109/91.873577>
- [12] O.Castillo, P.Melin, Type-2 Fuzzy Logic: Theory and Applications (Studies in Fuzziness and Soft Computing), Springer-Verlag, Berlin, 2008.
- [13] M.E. Yuksel, A. Basturk, "Application of Type-2 Fuzzy Logic Filtering to ReduceNoise in Color Images", Computational Intelligence Magazine, IEEE, August 2012; 7(3): 25-35. <http://dx.doi.org/10.1109/MCI.2012.2200624>
- [14] S. Schulte, M. Nachtgael, and V. De Witte, "A fuzzy impulse noise detection and reduction method," IEEE Trans. Image Processing. 2006; 15: 1153–1162. <http://dx.doi.org/10.1109/TIP.2005.864179>
- [15] J. R. Castro, O. Castillo, P. Melin, "An Interval Type-2 Fuzzy Logic Toolbox for Control Applications,"IEEE International conference on Fuzzy Systems. July 2007: 1-6.
- [16] C.L.Chen ,F.C. Kuo. "Design and analysis of a fuzzy logic controller", Int. J. Syst. Sci. 1995; 26: 1223 -1248. <http://dx.doi.org/10.1080/00207729508929095>
- [17] B.Safarinejadian, P.Ghane,"Design of Fuzzy controller for hydraulic industrial systems",12rd Iran Conference on fuzzy systems, Mazanderan Univercity, Iran,2012.